

User Manual

SUSPENSION FORKS

▲ WARNING!

Carefully read, understand and follow the instructions provided in this manual, and keep it in a safe place for future reference. If you have any doubt whatsoever regarding the use or maintenance of any SR SUNTOUR product, please contact SR SUNTOUR. Failure to follow these warnings and instructions can result in product malfunction, causing an accident, severe injury or death.

| | |
|-----------------------------------|----|
| Overview..... | 2 |
| Important safety information..... | 3 |
| Before every ride..... | 3 |
| Fork assembly..... | 4 |
| Tyre clearance..... | 4 |
| Tyre clearance test..... | 4 |
| 15mm bolted axle assembly..... | 5 |
| 20 mm bolted axle assembly..... | 5 |
| 20 mm cross axle assembly..... | 6 |
| Q-LOC assembly instructions..... | 6 |
| Air pressure and “SAG”..... | 7 |
| Coil spring preload..... | 8 |
| Maintenance of the fork..... | 8 |
| Maintenance plan..... | 8 |
| Limited warranty..... | 8 |
| Web links..... | 10 |
| Intended use..... | 11 |



We have language options for CN, DE, EN, ES, FR, IT, JA & NL on our website. Please navigate to:

www.srsuntour-cycling.com > Service > Download area > Consumer Downloads > Bike > Owners manuals > General Fork Manual

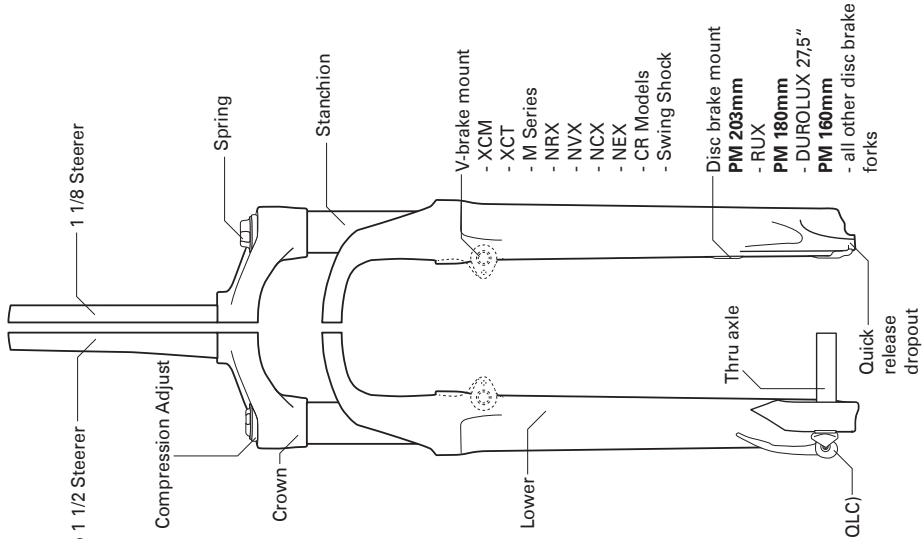

TIGHTENING TORQUES

| | |
|--|------|
| Spring side, top, plastic | 5Nm |
| Spring side, top, aluminum | 20Nm |
| Spring side, lower, allen screw (fix travel) | 10Nm |
| Spring side, lower, alloy nut (fix travel) | 8Nm |
| Spring side, lower (travel adjust) | 7Nm |
| Damping side, top, plastic | 5Nm |
| Damping side, top, aluminum | 20Nm |
| Damping side, lower, without adjuster | 10Nm |
| Damping side, lower with adjuster | 7Nm |
| Crown clamps | 7Nm |

⚠ WARNING!

For proper torque of the brake mount, please refer to the manuals provided by the brake manufacturer.

| Max. disc Ø | Stanchion Ø |
|-------------|----------------------|
| 203mm | 38, 36, 35, 34mm |
| 180mm | 32, 30, 28mm |
| 160mm | 25.4mm & Swing Shock |

Q-LOC
(all models tagged with QLC)

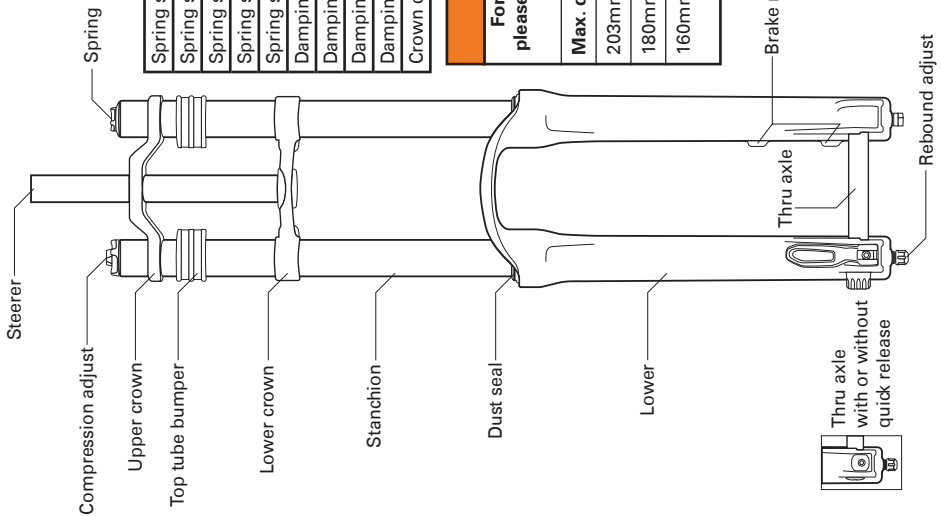

IMPORTANT SAFETY INFORMATION

▲ WARNING!

Failure to follow all warnings and safety instructions can cause your product to malfunction, resulting in an accident, severe personal injuries or even death to the rider.

- ▶ Read this manual thoroughly before using your suspension system.
- ▶ These instructions contain important information about the correct installation, service and maintenance of your suspension system. Common mechanical knowledge may not be sufficient. Your suspension system should only be installed, serviced and/or maintained by a trained and qualified bicycle mechanic with specialized tools.
- ▶ Our suspension systems contain fluids and gases under extreme pressure. Never try to open any SR SUNTOUR suspension system! Pieces can be violently ejected.
- ▶ SR SUNTOUR suspension systems are designed as a single integrated system. To avoid product malfunction and an accident, only use genuine SR SUNTOUR spare parts. The use of third-party supplier spare parts also voids the warranty of your suspension system.
- ▶ Your suspension system is not intended for jumps, aggressive downhill rides, freeride or dirtjumping if the warning sticker on your suspension system prohibits these activities. Disregarding these instructions may cause your product suspension system to fail, resulting in an accident, personal injury or death, and will void the warranty.
- ▶ SR SUNTOUR suspension system is designed for use by a single rider.
- ▶ Select the correct suspension system according to your frame's dimensions and your personal riding style. Installing a suspension system which does not match the geometry of your frame could result into a failure of the suspension system or frame itself, and will void the shocks warranty.
- ▶ Know the limits of your skill and experience, and never ride beyond them.
- ▶ Read, understand and follow all owner's manuals provided with your bike and all of its components.
- ▶ Always be equipped with proper safety gear. This includes a properly fitted and fastened helmet. According to your riding style you should use additional safety protection. Make sure your equipment is in flawless condition.
- ▶ Even if you had a suspension system in the past, ride carefully and slowly to become accustomed to the feel of your new suspension system.
- ▶ SR SUNTOUR suspension systems are not equipped with front reflectors for use on public roads. If you intend to use your bicycle on public roads or bicycle paths, you must install the required front reflectors. Please contact your dealer.
- ▶ If you are using a bicycle rack that requires the front wheel to be removed, carefully insert and remove the drop outs from the bike rack. Do not bend the drop outs!
- ▶ If you are using a bicycle rack that fastens the bicycle at the front drop outs only, then the rear wheel must be securely fastened to prevent movement of the rear wheel. Movement of the rear wheel will damage the front drop outs, and this damage may not be visible to you.
- ▶ If the bicycle has fallen off the bicycle rack, have it inspected by a qualified bicycle mechanic before riding it again

BEFORE EVERY RIDE

▲ WARNING!

Avoid serious personal injury or even death. Do not ride the bicycle if any of the following criteria is not met! Correct any condition before you ride.

- ▶ Inspect your bicycle and suspension system including the handlebars, pedals, crank arms, seat post, saddle, etc. for any cracks, dents, bent or tarnished parts. Also search for any oil leaking out of your shocks. Be sure to check hidden areas on the underside of your bike. If any condition exists, consult a trained and qualified bicycle mechanic to determine the cause and make any necessary correction.
- ▶ Compress your suspension system with your body weight. If it feels too soft, make the necessary adjustments until you have reached the correct SAG value. Please also see the instruction in this manual regarding SAG.
- ▶ Make sure your brakes are properly installed/adjusted and work correctly.
- ▶ Spin the wheels. Make sure that wheels are perfectly centered and do not contact the suspension system or brakes.
- ▶ If you are using a quick release system to fasten your wheel set, make sure that all levers and nuts are properly tightened. In case you are using a through axle system, make sure that all fixing bolts are tightened with the appropriate torque values. Strictly follow the instructions provided by the manufacturer of the quick release or through axle system.
- ▶ Check the cable length and routing of your components. Make sure they do not interfere with your steering of the bicycle.
- ▶ If you are using reflectors for on-road cycling, make sure they are clean and properly installed.
- ▶ Check mounting hardware of all components to make sure everything is tight.
- ▶ Bounce your bike on the ground while looking and listening for anything which might be loose.

⚠ WARNING!

Avoid product malfunction, an accident, personal injury or death. Your new SR SUNTOUR suspension system should be installed, maintained and serviced by a qualified and trained bicycle mechanic.

⚠ WARNING!

Avoid product failure and an accident, personal injury or death. All mounting screws must be tightened with the respective torques specified by the manufacturer of each individual component (i.e., brake, headset, etc.).

1. Remove the old fork from your bicycle. Remove the headset cup from the fork.
2. Measure the length of the steerer tube of your old fork and compare it to the length of the steerer tube of the SR SUNTOUR fork. The standard length of SR SUNTOUR suspension fork steerer tubes is 255 mm. It may be necessary to shorten the steerer tube to the correct length
3. Install the fork bearing race firmly at the top of your fork crown. Reattach the fork assembly (headset, spacer, handlebar stem) to the bicycle. Adjust the headset until no more play is observed. Further information can be found in the installation instructions of the headset manufacturer.

You can use the following formula to determine the proper length of the steerer tube: Head tube of the frame + Headset height + Spacer if applicable + Height of the stem - 3 mm distance = Length of the steerer tube

4. Install and properly adjust the brakes according to the brake manufacturer's instructions. If you are using a disc brake, install the brake only into the designated receptacle hole for the disc brake. Use only cantilever brakes that are made for use without support system. Follow the assembly instructions of your brake manufacturer. Select the proper length for the brake cable so that it does not interfere with the fork or steering.
5. Reattach the front wheel. Make sure that all clamping levers and nuts are set and tightened properly (at least four threads must engage in the nut when the quick release is locked). If the fork is equipped with a thru-axle system, then all screws must be checked for proper torque. Follow the instructions of the Quick Release or Turn-Axle manufacturer.

TYRE CLEARANCE

Please check in advance whether the wheel and fork are compatible. The necessary information can be found on the side of the tyre. Every tyre has a different external diameter (width and height of the tyre). For this reason, check the distance between your tyre and the fork to make sure your tyre does not touch the fork under any circumstances. Bear in mind that the narrowest part of the fork is at the brake boss level. If you want to remove your tyre, you must release the air from your tyre, among other things, in order to fit it through the brake boss socket.

⚠ WARNING!

Using a tyre that is larger than the maximum tyre size for your fork is very dangerous and can cause accidents, serious injuries and even death.

TYRE CLEARANCE TEST

⚠ WARNING!

Inadequate tyre clearance will result in sudden and unexpected loss of bicycle control, an accident, personal injury or death.

1. Depressurize the fork. (if equipped with air suspension)
2. Compress the fork together all the way.
3. Measure the distance between the top of your tyre and the underside of the fork crown. The distance must not be less than 10 mm! If the tyre is too big, it will touch the underside of the crown when the fork is fully compressed.
4. Relieve the fork and pump it up again if it is an air fork.
5. Take into account that the gap is reduced if you are using a fender! Repeat the "tyre distance test" to ensure that the distance is sufficient. You must repeat this test every time you change your tyres to another size!

15MM BOLT AXLE ASSEMBLY

ASSEMBLY

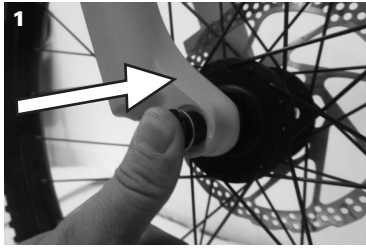

Fully insert the axle on the drive-side.

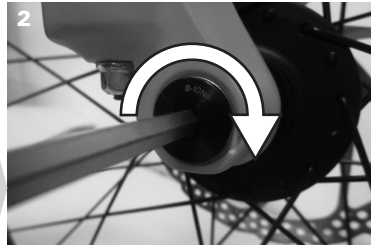

Tighten the axle with a 5mm allen key to 8-10Nm.

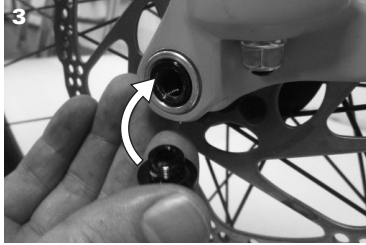

Insert the locking screw on the non-drive-side.

Tighten it with a 5mm allen key to 5-6Nm.

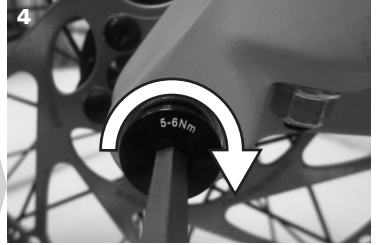

REMOVAL



Loosen the locking screw on the non-drive-side with a 5mm allen key.

Remove the locking screw from the axle.



Loosen the axle on the drive side with a 5mm allen key.

Pull out the axle.

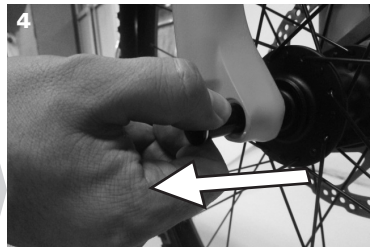

20MM BOLTED THRU AXLE ASSEMBLY



Slide in the axle and tighten it with a 6mm allen key to 10Nm.

Tighten the security clamp with a 4mm allen key to 7Nm.



20MM CROSS AXLE ASSEMBLY



Slide in the axle on the quick-lock side.



Tighten the axle with the red lever.

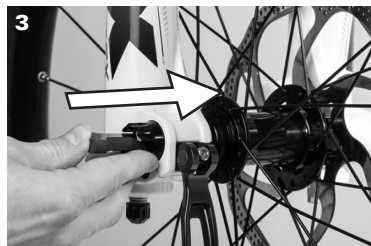

It is now possible to slide the lever into the axle.



Lock the quick release.

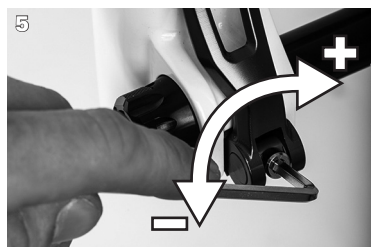

Set the tensioning force with a 4 mm allen wrench if needed.



The lever should be flush to the bottom case.

Q-LOC ASSEMBLY INSTRUCTIONS

ASSEMBLY



Check the flange to be expanded before installation and open the lever completely.



Slide in axle until it "clicks".

Make sure the flange is expanded.

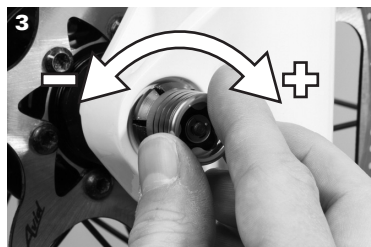

Set the tension with a semi-open lever until the flange is flush with the dropout.



Lock the lever completely. Check if firmly seated and re-tighten if necessary.

REMOVAL

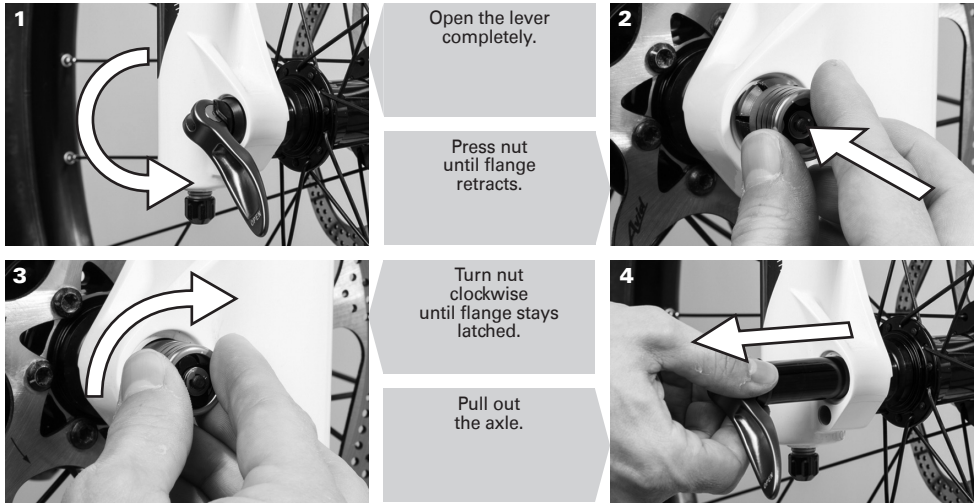

AIR PRESSURE AND "SAG"

The "SAG" (negative spring stroke) is the compression which is just caused by the rider's weight, including equipment (such as backpack), seating position and the frames geometry. SAG is not as a result of riding. Every rider has a different weight and seating position. The "SAG" depends on the position and weight of the rider and should be between 15% and 30% of the fork's max travel depending on the intended use and preferences.



1. Unscrew the valve cap. Screw a fork / shock pump onto the valve.
2. Pump the suspension fork up to the desired pressure. Never exceed the recommended maximum air pressure. Note the table below.
3. Sit on the bicycle in normal riding position and check the "SAG". Add or release air as needed. In order to properly assess the "SAG", attach a cable zip tie to the fork stanchion. You can lean against a wall in order to be able to sit still on the bicycle, in order to measure the "SAG".

| Rider weight (kg) | Suggested air pressure (psi) | | | | |
|----------------------|------------------------------|--------------------------|---------------|---------------|---------------------------|
| | RUX | DUROLUX/ AU- RON/AION | EPIXON TR | AXON | EPIXON XC/ RAIDON/ XCR |
| <55 | <40 | 35 - 50 | 40 - 55 | 40 - 55 | 40 - 55 |
| 55 - 65 | 40 - 50 | 50 - 60 | 60 - 70 | 55 - 65 | 55 - 65 |
| 65 - 75 | 50 - 60 | 60 - 70 | 70 - 80 | 65 - 75 | 65 - 75 |
| 75 - 85 | 60 - 70 | 70 - 85 | 80 - 90 | 75 - 85 | 75 - 85 |
| 85 - 95 | 70 - 80 | 85 - 100 | 90 - 105 | 85 - 95 | 85 - 95 |
| >100 | 85+ | 105+ | 105+ | 100+ | 100+ |
| Max. Pressure | 100psi | 150psi | 180psi | 165psi | 180psi |

COIL SPRING PRELOAD

The fork can be adjusted to the rider's weight and preferred riding style via the spring preload. It is not the coil spring hardness that is set, but the spring preload. This reduces the "SAG" of the fork when the rider sits down. A semi-hard spring is used by default. Turn the preload adjust knob clockwise to increase the spring preload and turn it counter-clockwise to reduce it. Two additional spring stiffnesses are available for SR SUNTOUR suspension forks - softer and harder than the standard coil spring.



MAINTENANCE OF THE FORK

As long as moving parts are exposed to moisture and contamination, the performance of your suspension system might be reduced after several rides. To maintain high performance, safety and long life of your suspension system, periodic maintenance is required.

- ▶ **A suspension system which has not been serviced in accordance with the maintenance instructions will not be covered under warranty.**
- ▶ **Never use a pressure washer or any water under pressure to clean your suspension system as water may enter the shock at the dust seal level. Never use aggressive cleaners. We recommend clear water and a damp cloth to wipe down your shock.**
- ▶ **Your suspension system should be serviced more frequently as indicated below if you ride in extreme weather (winter time, or in wet/muddy conditions) and rough terrain conditions.**
- ▶ **If you believe that your suspension system performance has changed or handles differently, immediately contact your local dealer to inspect your fork.**

MAINTENANCE PLAN

- ▶ after every ride: Clean the fork tubes and dust seals and maintain with an oily cloth. Check stanchion tubes for dents, scratches or other discoloration or leaking oil.
- ▶ every 50 hours: Maintenance 1 (at dealer)
- ▶ every 100 hours or once a year: Maintenance 2 (at dealer, ideally before winter time in order to protect all parts from the effects of weather by proper greasing)

MAINTENANCE 1:

Check function of fork / check torques of mountings screws and nuts on bottom of lowers (steel 10 Nm, alloy 4Nm) / check for scratches, dents, cracks, discoloration, signs of wear and signs of minor corrosion (maintain with oily cloth), or oil leaks.

MAINTENANCE 2:

Maintenance 1 + disassembly / cleaning the entire fork inside and out / cleaning and lubricating dust seals and slider sleeves / checking torques / adjusting to the riders liking. Before disassembly, check the slider sleeve play of the fork. To do so, apply the front wheel brake and gently push the bicycle back and forth at the handlebar stem shaft. Replace the slider sleeves if the play is excessive (more than 1 mm at the fork brace).

LIMITED WARRANTY

COVERAGE

SR SUNTOUR, INC. ("WARRANTOR") warrants that each SR SUNTOUR PRODUCT will be free from defects in material and workmanship for a period of TWENTY FOUR (24) months (TWELVE (12) months on damper, SIX (6) months on seals, slider sleeves & bushings) from the date of the first retail purchase of the PRODUCT. The Limited Warranty is referred to herein as "the Limited Warranty." The PURCHASER's sole and exclusive remedy under this Limited Warranty for defects in the PRODUCT shall be the repair or replacement, in WARRANTOR's sole discretion, of the defective PRODUCT, or components thereof.

ACTIVATION OF WARRANTY

In order to activate limited warranty coverage, the first retail PURCHASER (hereinafter referred to as "PURCHASER") must register the purchase of the PRODUCT on line at www.SR SUNTOUR-CYCLING/Warranty.com within seven (7) days of purchase of the PRODUCT.

NOT COVERED

This Limited Warranty does not apply to, will be deemed null and void, and WARRANTOR shall have no liability or responsibility in respect of, damages or expenses relating to:

- ▶ The failure to properly install, use, maintain, store, or transport PRODUCT as, for example, specified in any manuals or other literature supplied by WARRANTOR, on WARRANTOR's website, or in accordance with any applicable laws, codes, regulators or standards;
- ▶ Improper specification or application of the PRODUCT as a sub component on a different product;
- ▶ Any PRODUCT purchased from any entity other than WARRANTOR, WARRANTOR's OEM (original equipment manufacturer) customers, or WARRANTOR's authorized dealers;
- ▶ Alteration, change or modification of the PRODUCT, including its subcomponents, parts or assemblies;
- ▶ Cosmetic issues, such as scratches, chips or colour deviations;
- ▶ Accidents, neglect, misuse, abuse, improper use, lack of reasonable or proper maintenance, improper assembly, repairs improperly performed, replacement parts or accessories not conforming to WARRANTOR's specifications, use exceeding the recommended and permitted limits of the PRODUCT, or not following the warranty procedure set forth herein.;
- ▶ Activities such as acrobatics, stunt riding, ramp riding, racing, and/or normal wear or deterioration occasioned by the use of the PRODUCT. Items subject to normal wear or deterioration include but are not limited to oil, dust seals, oil seals, o-rings, bushings, bearings, rubber moving parts, stanchion tubes, bearings, and cartridges;
- ▶ Any components of any other assembly on which a PRODUCT may be installed, and which may be damaged as a result of the failure of a PRODUCT;
- ▶ Any expenses related to the transportation of the PRODUCT to or from an authorized service center, labor costs to remove the PRODUCT from the bicycle, or compensation for loss of use while the PRODUCT is being repaired;
- ▶ Any defect or non-conformity that has not been timely and promptly communicated in writing to WARRANTOR or WARRANTOR's authorized representative as set forth herein;
- ▶ Any damage, cost or expense caused by Act of God; or
- ▶ Loss of time, loss of use, inconvenience, loss of profits, lost business, lost business opportunities, damage to reputation, goodwill and any incidental or consequential damages arising out of or relating to the PRODUCT, or other matters not specifically covered hereunder.

This warranty will be automatically and immediately null and void if the serial number of the PRODUCT is altered, erased, defaced or otherwise subject to any tampering. In addition, any use of the PRODUCT with a rental or leased bicycle or for any other commercial use (i.e. on a messenger bike) shall render the Limited Warranty immediately null and void.

PROCEDURE

In the event of an alleged defect covered by this warranty, PURCHASER shall, within ten (10) calendar days of learning of the alleged defect, contact the authorized retailer from which PURCHASER purchased the PRODUCT to give specific and detailed notice of any non-conformities or defects regarding the PRODUCT. This notice shall include photographs of the PRODUCT and including photographs of the alleged defect, a copy of the proof of purchase, and the serial number of the PRODUCT. In addition, the maintenance history of the PRODUCT must be submitted with the warranty claim. Within thirty (30) days thereafter, the PURCHASER will be advised of whether the limited warranty claim is accepted or rejected. If accepted, the PURCHASER will be advised of the remedy to be provided pursuant to the terms and conditions of this Limited Warranty.

In the event WARRANTOR, in its sole discretion, decides to replace the PRODUCT, but the same PRODUCT is no longer available, WARRANTOR may replace the PRODUCT with a different product of equal or higher value to the PRODUCT.

The PURCHASER forfeits any rights it may have under this Limited Warranty if the PURCHASER does not follow the procedure described herein.

LIMITATION OF DAMAGES

Except as expressly provided by this Limited Warranty, Warrantor **SHALL NOT BE RESPONSIBLE FOR ANY INCIDENTAL OR CONSEQUENTIAL DAMAGES ASSOCIATED WITH THE USE OR NON-USE OF THE PRODUCT OR A CLAIM UNDER THIS LIMITED WARRANTY, WHETHER THE CLAIM IS BASED ON CONTRACT, TORT OR OTHERWISE.** The foregoing statements of warranty are exclusive and in lieu of all other remedies or damages. Some states do not allow the exclusion or limitation of incidental or consequential damages, so this limitation or exclusion may not apply to you.

DISCLAIMER

ANY IMPLIED WARRANTY OF MERCHANTABILITY OR FITNESS FOR A PARTICULAR PURPOSE AND ALL IMPLIED WARRANTIES ARISING FROM A COURSE OF DEALING, USAGE OF TRADE, BY STATUTE OR OTHERWISE, IS HEREBY STRICTLY LIMITED TO THE TERM OF THIS WRITTEN WARRANTY.

This Limited Warranty shall be the sole and exclusive remedy available to the PURCHASER with respect to this PRODUCT. In the event of any alleged breach of any warranty or any legal action brought by the PURCHASER based on breach of warranty, alleged negligence or other tortious conduct by WARRANTOR, the PURCHASER'S sole and exclusive remedy will be repair or replacement of defective materials or refund of the purchase price, as stated herein. In no event shall the liability of the WARRANTOR exceed the purchase price of the PRODUCT.

NO TRANSFER OF LIMITED WARRANTY

This warranty is made by WARRANTOR with only first PURCHASER of the PRODUCT and does not extend to any subsequent PURCHASER or any third parties. The unexpired portion of this Limited Warranty may not be transferred to any entity.

APPLICABLE LAW

Any and all claims or disputes of whatever nature arising out of or otherwise relating to this Limited Warranty shall be governed by and construed in accordance with the laws of the State of New York only, and the parties expressly acknowledge and irrevocably agree that the sole and exclusive venue for and jurisdiction over any such claim or dispute shall be the state or Federal courts sitting in White Plains, New York to the exclusion of the jurisdiction of the courts of any other place, without giving effect to choice of law principles and without giving effect to the United Nations Convention regarding contracts for the International Sale of Goods (which the parties expressly exclude).

OTHER RIGHTS

Your acceptance of delivery of the PRODUCT constitutes your acceptance of the terms of this Limited Warranty.

This Limited Warranty gives you specific legal rights, and you may also have other rights which vary from state to state. If any term or provision of this Limited Warranty is invalid or unenforceable under any local, state, or federal law, statute, judicial decision, regulation, ordinance, executive order or other rule of law, such term shall be deemed reformed or deleted, but only to the extent necessary to comply with such statute, regulation, ordinance, order or rule and the remaining provisions of this Limited Warranty shall remain in full force and effect.

ENTIRE AGREEMENT

This document alone contains the entire Limited Warranty given by WARRANTOR in respect of the PRODUCT. Nothing in WARRANTOR's product literature, marketing materials, advertisements and technical specifications expand or enlarge the scope of this Limited Warranty. There are no terms, promises, conditions or warranties regarding the PRODUCT other than those expressly contained herein. WARRANTOR specifically does not authorize any person, including but not limited to any dealer or other agent or employee of WARRANTOR, to extend the time, scope, terms or conditions of this Limited Warranty or to create or assume for Warrantor any other obligation or liability with respect to the Product or other products designed, manufactured or sold by Warrantor. All terms of this Limited Warranty are contractual and not mere recitals, and constitute material terms of this Limited Warranty. It is agreed and acknowledged that the provisions of this Limited Warranty allocate the risks between WARRANTOR and PURCHASER, that WARRANTOR's pricing reflects this allocation of risk, and but for this allocation and limitation of liability, WARRANTOR would not have entered into this Limited Warranty.

WEB LINKS

For further information please visit our website: www.srsuntour-cycling.com.

There you will also find:

- ▶ Service request:
<http://www.srsuntour-cycling.com/service/service-request>
- ▶ Product registration:
<http://www.srsuntour-cycling.com/service/product-registration>
- ▶ Tech videos:
<http://www.srsuntour-cycling.com/service/tech-videos>
- ▶ Download area:
<http://www.srsuntour-cycling.com/service/download-area>
- ▶ Owners manuals:
<http://www.srsuntour-cycling.com/service/download-area/consumer-downloads/bike/owners-manuals/>
- ▶ Fork glossary:
<http://www.srsuntour-cycling.com/service/fork-glossary>
- ▶ Warranty:
<http://www.srsuntour-cycling.com/service/warranty>

INTENDED USE

| | | | | | | | | | |
|-----------------|---|---|---|---|---|---|---|---|---|
| RUX Double C | | 0 | | | 0 | | | | |
| RUX | | 0 | | | 0 | | | | |
| DUROLUX36 Boost | 0 | 0 | | | | 0 | | | |
| DUROLUX | | | | | | 0 | | | |
| AURON35-Boost | | 0 | | | | | 0 | | |
| AURON | | | | | | | 0 | | |
| AION35-Boost | | 0 | | | | | 0 | | |
| AION | | | | | | | 0 | | |
| ZERON 35 | | 0 | | | | | 0 | | |
| AXON werx F | | | | | | | | 0 | |
| AXON werx | | | | | | | | 0 | |
| AXON34-Boost | | 0 | | | | | | | 0 |
| AXON | | | | | | | | | 0 |
| EPIXON 9 | | | | | | | | | 0 |
| RAIDON34 | | 0 | | | | | | | 0 |
| RAIDON32 650B+ | | | | | | | | | 0 |
| RAIDON32 | | | | | | | | | 0 |
| XCR34 | | 0 | | | | | | | 0 |
| XCR32 650B+ | | | | | | | | | 0 |
| XCR32 | | | | | | | | | 0 |
| XCR24" | | | | | | | | | 0 |
| XCM34 | | 0 | | | | | | | |
| XCM32 650B+ | | | | | | | | | 0 |
| XCM | | | | | | | | | 0 |
| XCM-ATB | | | 0 | | | | | | |
| XCM28 24"+ | | | | | | | | | 0 |
| XCT | | | | | | | | | 0 |
| XCT ATB | | | 0 | | | | | | |
| XCT JR | | | | | | | | | 0 |
| XCT JR L | | | | | | | | | 0 |
| MOBIE45 | 0 | | | | | | | | |
| MOBIE25 | | 0 | | | | | | | |
| NEX-E25 | | 0 | 0 | | | | | | |
| CR85-E25 | | 0 | | 0 | | | | | |
| NRX | | | 0 | | | | | | |
| NVX | | | 0 | | | | | | |
| NCX | | | 0 | | | | | | |
| NEX | | | 0 | | | | | | |
| CR9 | | | | 0 | | | | | |
| CR8 | | | | 0 | | | | | |
| CR7 | | | | 0 | | | | | |
| M3030 | | | 0 | 0 | | | | | |
| M3010 | | | 0 | 0 | | | | | |

| USE FOR | | | | | | | | | |
|--|--|--|--|----------------------------------|----------------|------------------------------|-------------------------|---|---------------|
| Pedal assist bikes up to 45km/h for on-road or casual off-road | Pedal assist bikes up to 25km/h for on-road | Paved road and casual off-road | Paved road | | | Cross country, Trail, Enduro | Cross country, Trail | Cross country racing, Cross country | Cross country |
| DO NOT USE FOR | | | | May be used for any riding style | DO NOT USE FOR | | | | |
| Downhill, Enduro, Trail, Cross country racing, Cross country | Downhill, Enduro, Trail, Cross country racing, Cross country, off-road | Downhill, Enduro, Trail, Cross country racing, Cross country | Downhill, Enduro, Trail, Cross country racing, Cross country, off-road | | Downhill | Downhill | Downhill, Enduro, Trail | Downhill, Enduro, Trail, Cross country racing | |

SR SUNTOUR INC. (TAIWAN)

#7 Hsing Yeh Road,
Fu Hsing Industrial Zone Chang Hua,
Taiwan, R.O.C.
Tel: +886- (0)4-769-5115
Fax: +886- (0)4-769-4028
E-Mail: orders@srsuntour.com.tw

SR SUNTOUR (KUNSHAN) INTERNATIONAL CO.,LTD

No 1500 Honghu Road Kunshan Development Zone
Jiansu Province China 215333
Tel: +86 (0)512-55171127
Fax: +86 (0)512-55171117
Service e-mail: sr-service@srsuntour.com.cn

SR SUNTOUR EUROPE GMBH

*Sales, Customer Support
and Technical Services*

Riedstrasse 31
83627 Warngau, Germany
Tel: + 49 (0)8021 50 793-0
E-Mail: service@srsuntour-cycling.com

SRS INTERNATIONAL TRADING LTD.

Room 301 3th floor,building No 2 Jianxing
Industrial Zone Subei road
Gongming town Guangming district Shenzhen City, China 518106
Tel: +86 (0)755-27108483
E-mail: service@srsuntour.com.cn

SAV SR SUNTOUR France

Customer Support and Technical Services

604 voie Galilée
73800 Sainte Hélène du Lac, France
Tel: +33 (0)981241650
Fax: +33 (0)479286971
E-Mail: sav@srsuntour-cycling.com

SR SUNTOUR NORTH AMERICA

VANCOUVER, WASHINGTON
Warranty, Service and Aftermarket Sales

14511 NE 10th Avenue, Unit E,
Vancouver, Washington 98685 USA
Service and warranty tel: 1-360-737-6450
Service and warranty e-mail: service@srsuntourna.com
Sales tel: +1-855-205-BIKE(2453)
Sales e-mail: ssna@srsuntourna.com
Website: www.srsuntourna.com

MADISON, WISCONSIN
Warranty, Service, Sales and Marketing

910 Watson Avenue, Madison,
Wisconsin 53713 USA
Tel: 1-608-229-6610
Service and warranty e-mail: service@usulcorp.com
Sales e-mail: sales@usulcorp.com

ONLINE SALES
www.emarket.srsuntourna.com